

Single Hinged Door Installation Manual

Auto Closing

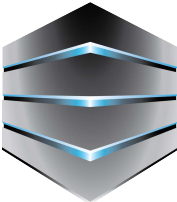

AMCO[®]
ENCLOSURES
an IMS Engineered Products Brand

Safety & Handling

When unpacking the Double Sliding Doors and components, be careful not to scratch the aluminum frame and the polycarbonate. They have been carefully packaged and inspected before crating. Inspect all components and be sure all required hardware is included for assembly. Reference the Packing Slip.

Use the proper tools for all assembly procedures as well as installation of the doors in and around the cabinets.

All movement and assembly requires two persons for safety and protection of the doors being installed and the equipment around them.

Tools List

$\frac{5}{16}$ " Hex Nut Driver	Phillips Driver	Extension Cord	Hammer	Rubber Mallet
Level	Tape Measure	$\frac{3}{16}$ " T-Handle Hex Wrench	$\frac{5}{32}$ " T-Handle Hex Wrench	$\frac{1}{8}$ " Allen Wrench
Step Ladder	$\frac{9}{32}$ " Drill Bit	Pencil	Fine Point Marker	String or Straight Edge
Floor Tile Installations:	$\frac{1}{4}$ " Masonry Bit	Hammer Drill		

Overview

1. Assemble the Door Frame by connecting the side panels to the header.
2. Place the Door Frame into position and **verify the header is level** and the Door Frame is aligned and plumb. Mount the Side Panels to the floor.
3. *Verify the header is level* and mount the header to the cabinet.
4. Attach the Handles and adjust the door close hardware

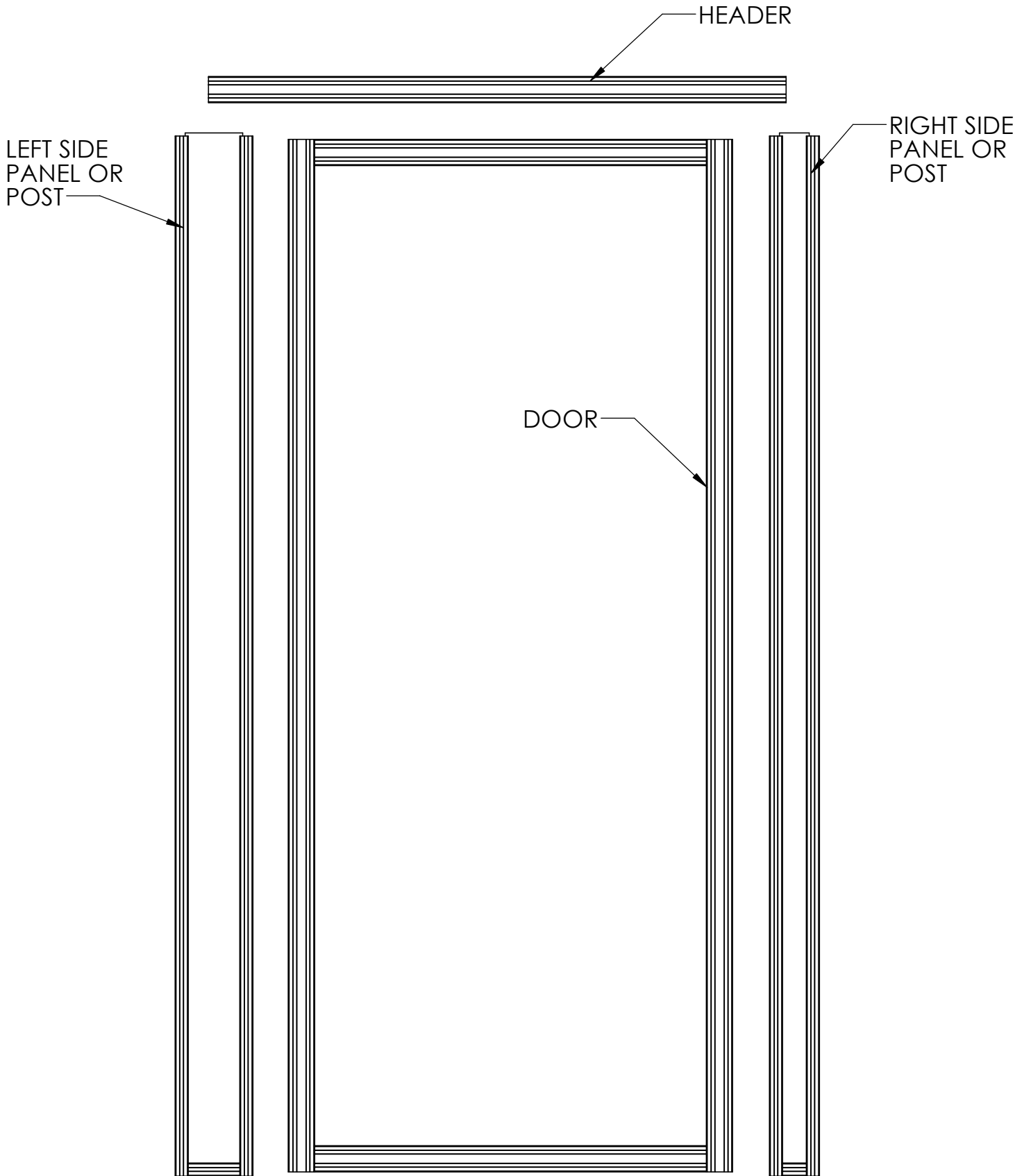

1. Assemble the Door and Side Panels/Post to the Header using the access holes on the top of the header and a 3/16" T-Handle allen wrench.
2. Attach the Door to the Side Panel.
3. Attach the Hinges to the door.
4. Using two people place the door into position.
5. Attach the Header to the Cabinet using the Formed Mounting Brackets and ensure proper gaps around the Door.

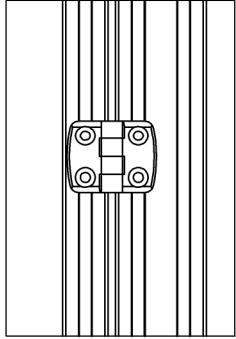

HINGE
ATTACHMENT

Attach to Header
and the Cabinet

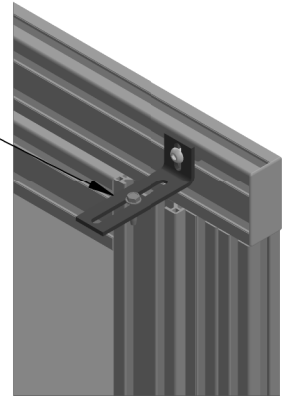

DETAIL A

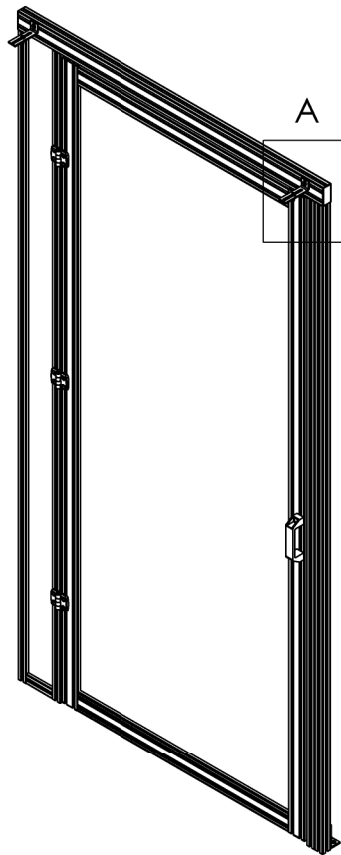

1. Place 2 Floor Mount Brackets on each Right and Left Side Panel/Post to secure the door frame to the floor. Place Floor Mount Brackets in the best site specific locations as needed to ensure the frame is secured properly.
2. Ensure proper gap around the door.

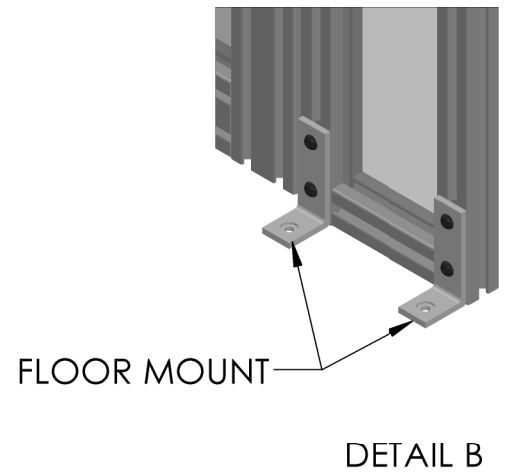
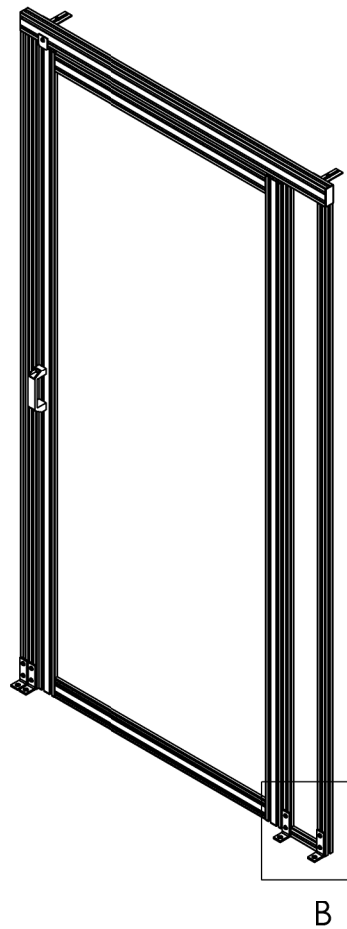

Attach Door Handles to the door

ATTCH DOOR
HANDLES TO
DOOR AND
ADJUST HEIGHT

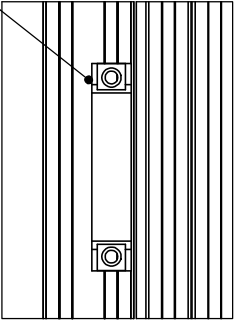

DETAIL C

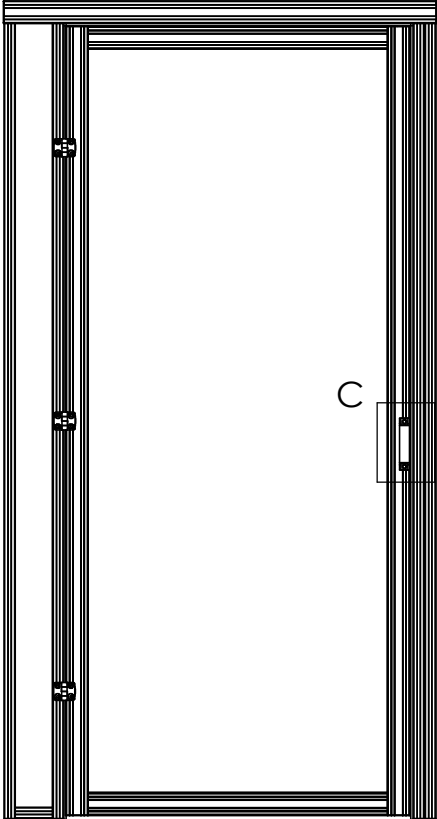

Attach Autocloser Assembly using screws provided. Auto Closer speed can be adjusted by turning the big screw at the end of the closer.

ATTACH 1/4-20 X 5/8" SCREWS PROVIDED

ATTACH 1/4-20 X 1/4" SCREWS PROVIDED

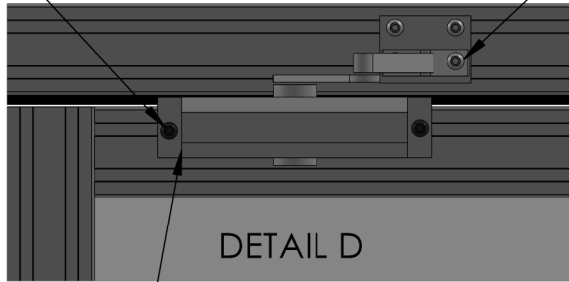

AUTOCLOSER SPEED ADJUSTMENT LOCATION

ATTACH TO BACK SIDE OF DOOR

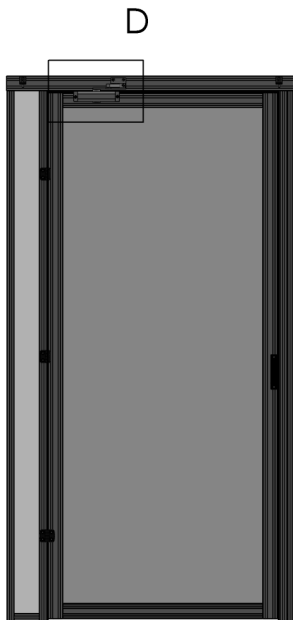
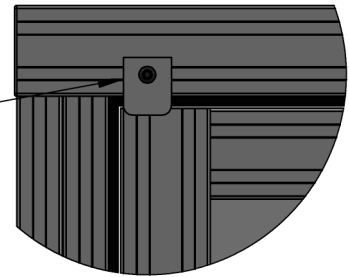

FRONT VIEW

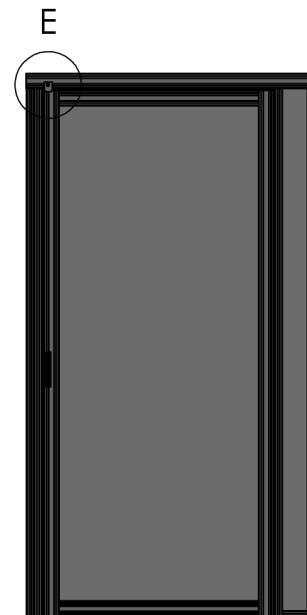

REAR VIEW