

TITAN ZN4

GR-63-CORE SEISMIC ENCLOSURE SERIES



AMCO[™]
ENCLOSURES
an IMS Engineered Products Brand
Racking Technology Since 1943

Titan ZN4 Series

Designed and
Manufactured in the USA 

IMS Engineered Products is
ISO9001 Certified

AMCO Enclosures Titan ZN4 Seismic Rack

Certified to Telcordia
GR-63-CORE 4.4



AMCO Enclosures Titan ZN4 seismic racks provide a safe, secure environment for sensitive equipment in areas where earthquakes can put systems at risk without notice. AMCO's Titan ZN4 rack has been engineered, tested and certified to meet Telcordia GR-63-CORE NEBS requirements for Zone 4 seismic and mechanical natural frequency requirements.

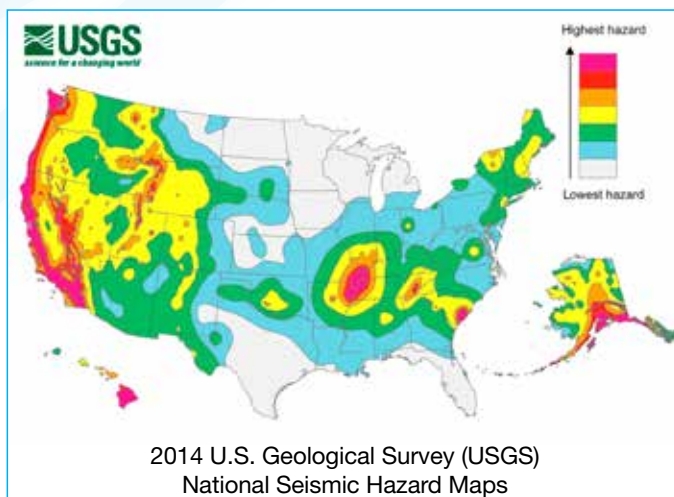

High Risk Seismic Zones in the U.S.A.

This map displays earthquake ground motions for various probability levels across the United States. The map represents an assessment of the best available science in earthquake hazards and incorporate new findings on earthquake ground shaking, faults, seismicity and geodesy.



AMCO Enclosures Titan ZN4 Series
www.amcoenclosures.com - 847-391-8100

GR-63-CORE and IBC Zone 4 Seismic Ratings

Telcordia GR-63-CORE and IBC Zone 4 Seismic Rating Overview

NEBS GR-63-CORE 4.4 The earthquake and vibration requirements are extensive—the rack design *must be tested* in a simulated Zone 4 seismic event (acceleration time waveform) on a shaker table where the rack is exposed to higher vertical and horizontal vibrations. The goal is that equipment installed will remain operational and safe *during* a zone 4 seismic event.

International Building Code (IBC) compliance also focuses on safety. It outlines ways to position and secure equipment (i.e. racks) using tie down brackets/hardware and engineers/architects that establish analytical calculations (horizontal and vertical force, center of gravity and maximum moment), to determine the rack's weakest point. Experience data can be used and, depending on the area and engineer,—varying results may occur.

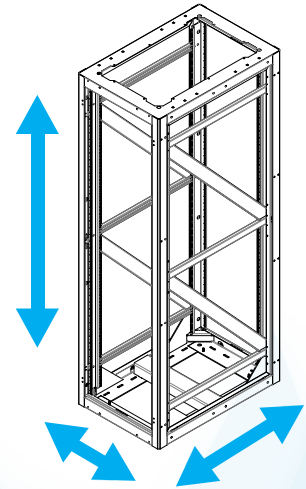

Structures in Zone 4 areas can be affected by ground vibration waves in vertical and horizontal plains simultaneously

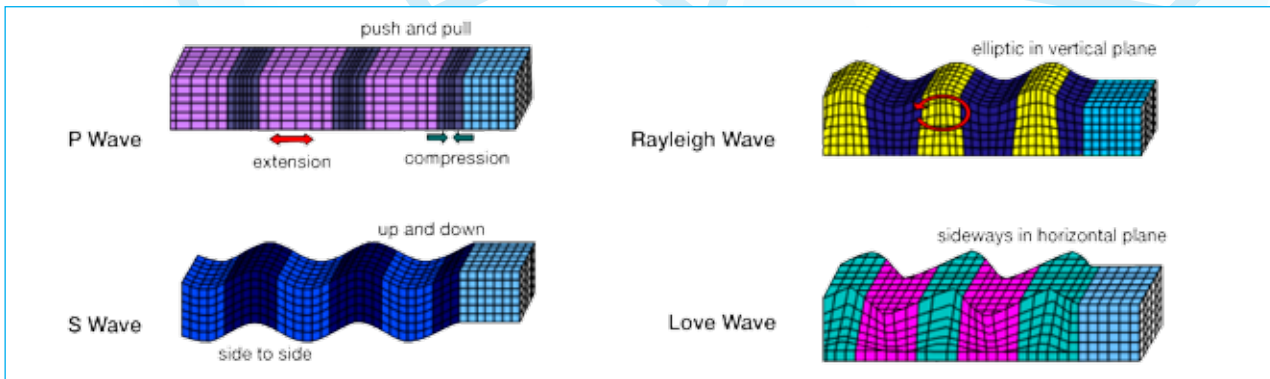

AMCO racks are fully welded, hardened and tested for seismic events up to 8.3 on the Richter scale. This includes nuclear facilities, severe weather areas and areas that might be exposed to extreme vibration.

Test results are available upon request.

HOW TO USE THIS CATALOG

Titan ZN4 racks are available for both Electronics Packaging (Test/Measurement, Automation, etc.) and Data (IT Infrastructure) application. The sections are color-coded as each section has various product options to those sectors of industry.

Titan ZN4 - Electronics Packaging

Titan ZN4 - Data



AMCO Enclosures Titan ZN4 Series
www.amcoenclosures.com - 847-391-8100

Titan ZN4 Seismic Series











IMS Engineered Products seismic cabinets are fully engineered and designed to keep your equipment safe in seismic areas where extreme vibration can affect your system's mission-critical electronics. Expand your system's capabilities by adding other AMCO accessories from either section of this catalog. Custom designs and colors are also available and quoted upon request.

Seismic Zone 4 Series Features

- Certified to Telcordia Specification NEBS GR-63-CORE, Issue 4
- 1,200lb (544KG) Seismic Load Rating
- EIA Standard 310D
- Fully welded steel construction
- Floor mounting hardware (Hilti) available
- 11 standard colors or custom color matching available
- Tested and approved for seismic events up to 8.3 magnitude
- Full line of accessories
- 10 Year Warranty
- Made in the USA



Frame Colors

	Pottery White 101-T
	Light Blue 111-T
	Silver 112-T
	Gunmetal 113-T
	Black 116-T
	Pearl Gray 122-T
	Pebble Gray 123-T
	Light Beige 125-T
	Cranberry 126-T
	Medium Blue 816-T
	Glacier White XCP-151T

Note: AMCO Enclosures offers standard color choices (up to 2 per console) for no extra charge. Custom colors are available and quoted upon request.

IMS has designed its NEBS GR-63-CORE seismic cabinets to be as easily configurable as its other enclosure series—allowing an almost infinite amount of flexibility in accessory selection choice.

Top Panels

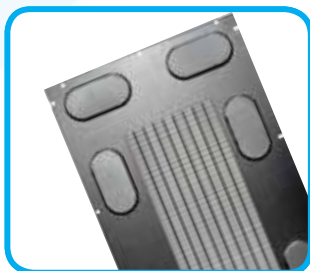

Top Panels include 8-10 cable egress ports in a variety of designs

Side Panels



Side Panels are available in bolt down

Doors

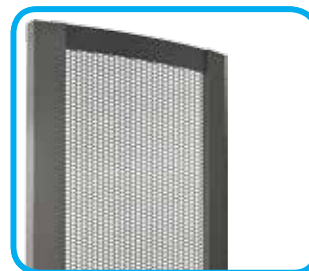

Door options include face or flush mount styles

Other Accessories



Expand your design with shelves, cable management and other accessories



AMCO Enclosures Titan ZN4 Series

www.amcoenclosures.com - 847-391-8100

Titan ZN4 Rack Construction Features

These are not standard racks that use IBC analysis and bolt-down hardware for certification, but rather engineered, hardened, fully welded, tested and certified racks intended for Zone 3 and 4 seismic areas.



Seam Internal/External

Internal and external seams of Titan ZN4 rack components have a continuous weld for enhanced strength.



Interior Side Gussets

Side gussets are seam-welded in all four corners above the Titan ZN4 base for enhanced support.



Lift-Eye Option

Lift-Eye option is available for applications where lift eyes are required to position Titan ZN4 racks into place.



Enhanced Side Struts

Diagonal struts are welded to horizontal uni-struts for additional strength.

Frame Base Construction

The Titan ZN4 base has multiple forms and is seam-welded. The center channel, side and corner gussets have been added for enhanced structural support.

Base has four ground studs 1/4-20 x 5/8" L

Optional Hilti™ Bolt-Down Kit is available.

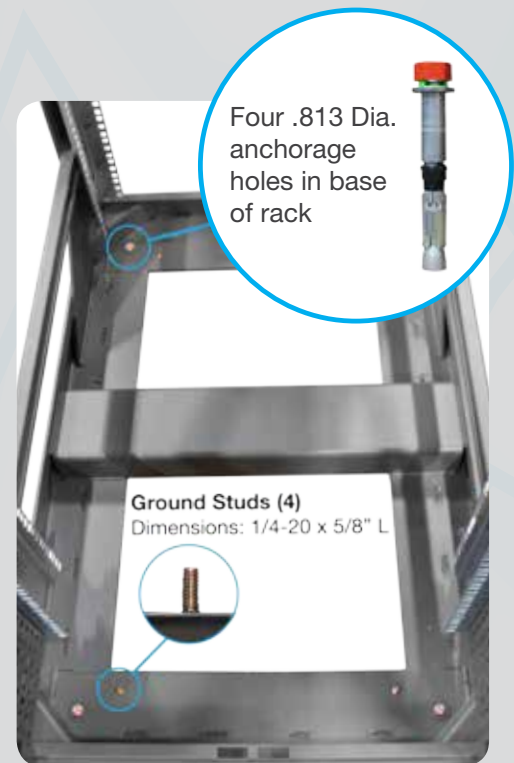

Four .813 Dia. anchorage holes in base of rack

Ground Studs (4)
Dimensions: 1/4-20 x 5/8" L

Ample space in rack base for power and cable management.

Use this catalog as a guide to design your rack online.



Titan ZN4 - Electronics Packaging

Certified to Telcoredia Specification NEBS GR-63-CORE 4.4
1,200 LB SEISMIC LOAD RATING

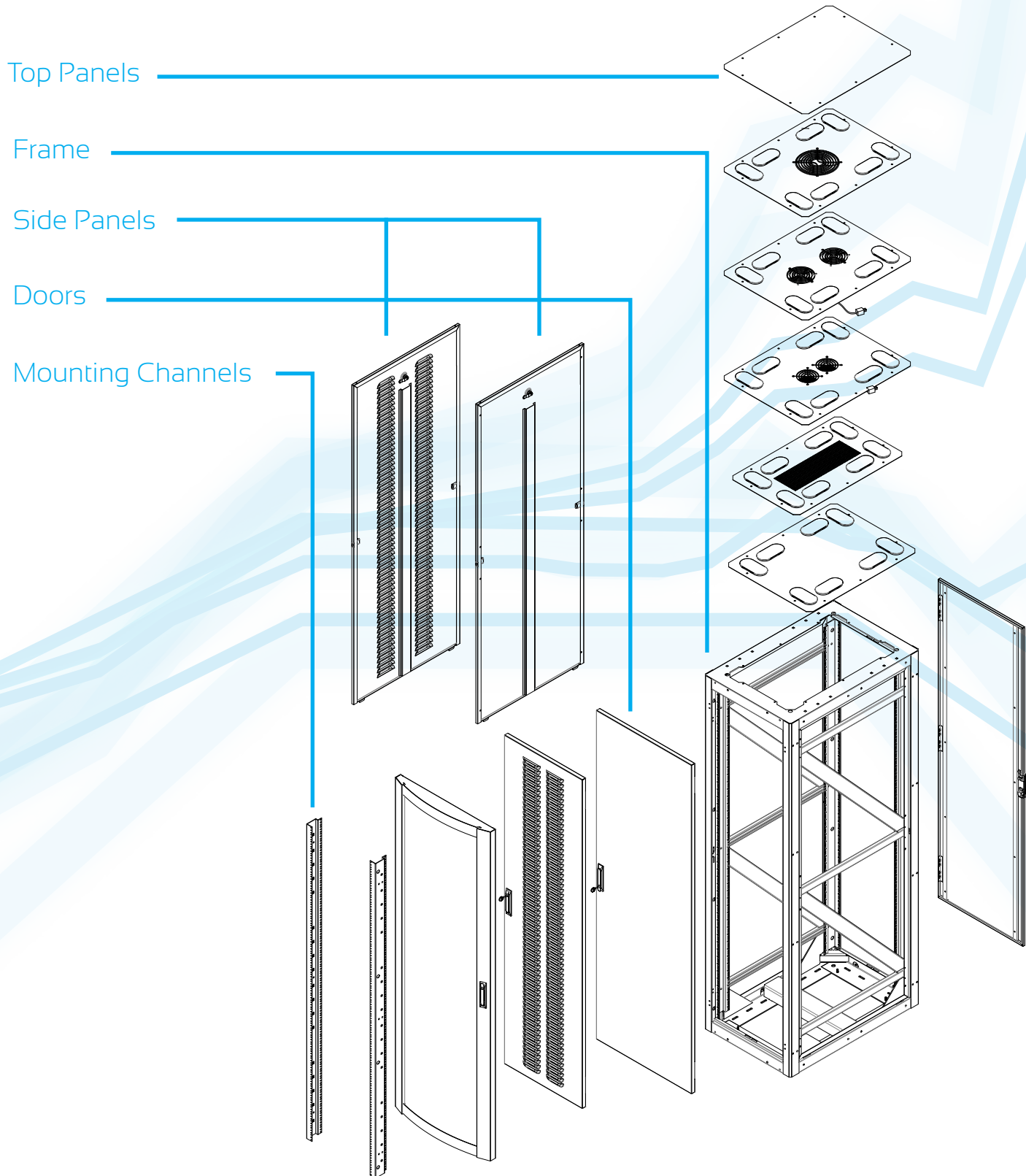

Titan ZN4 - Electronics Packaging

Titan EP vertical frames are available in the following sizes:

Panel Heights; 35RU, 40RU and 45RU

Frame widths: 24"

Frame depths: 25.5", 30" and 36"

Other sizes available and quoted upon request

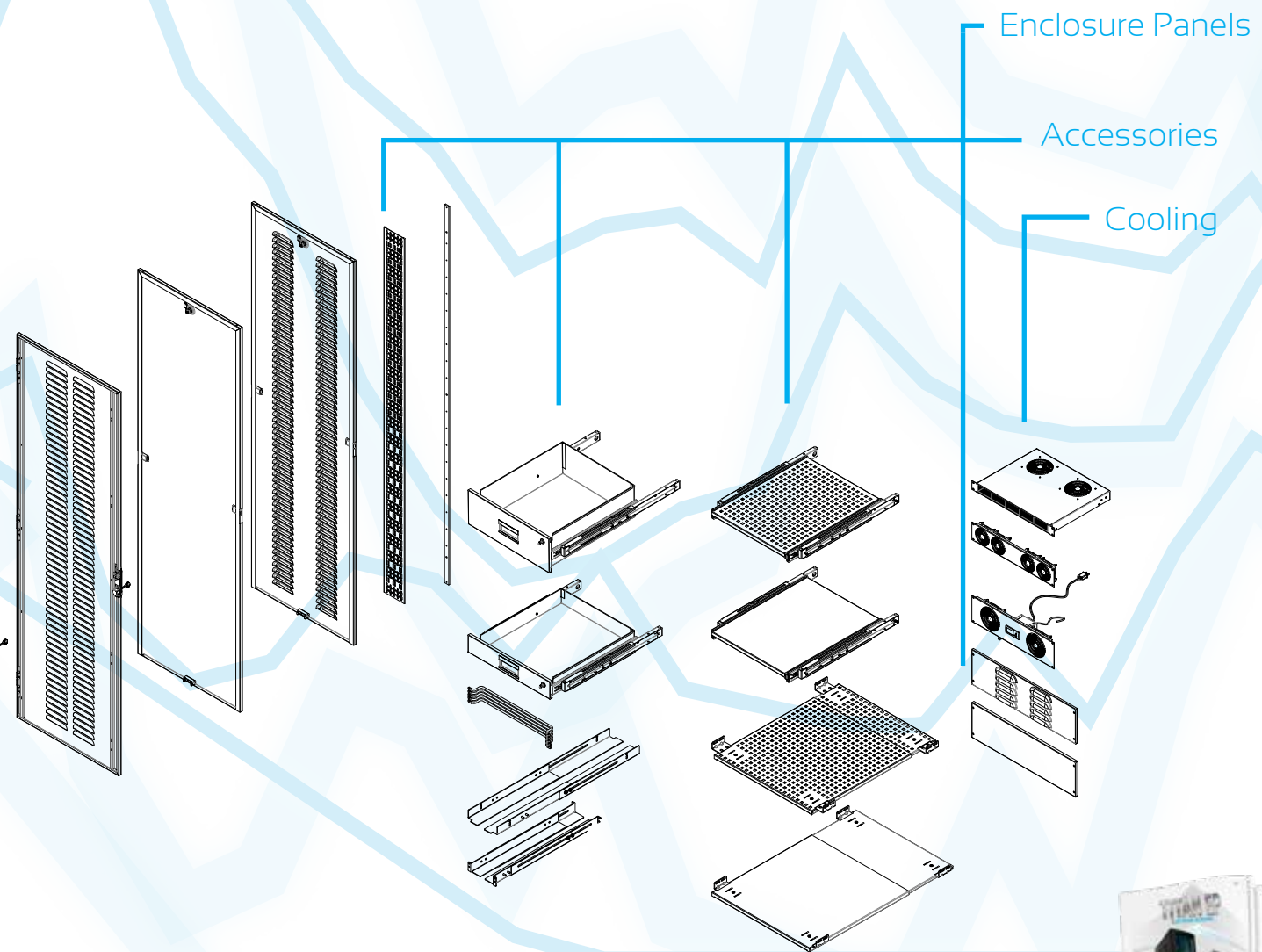

For more product information on specific parts,
please see AMCO Enclosures' Titan EP catalog.



AMCO Enclosures Titan ZN4 Series

www.amcoenclosures.com - 847-391-8100

Titan ZN4 - Electronics Packaging

AMCO Enclosures has designed its NEBS GR-63-CORE Titan ZN4 cabinets to be as easily configurable as its other enclosure series—allowing an almost infinite amount of flexibility in your accessory selection. Doors, side and top panels, cable management—all can be selected to expand the frame’s adaptation to each specific design requirement.

Frames



24" Width Frames
19" Panel Opening

24" Width Frames

RU Height	36" Depth
45	R-Z4-45U24-36
40	R-Z4-40U24-36
35	R-Z4-35U24-36

RU Height	30" Depth
45	R-Z4-45U24-30
40	R-Z4-40U24-30
35	R-Z4-35U24-30

RU Height	25.5" Depth
45	R-Z4-45U24-255
40	R-Z4-40U24-255
35	R-Z4-35U24-255

Note: Mounting channels not included.

Mounting Channels



MX Mounting Channels



MX Mounting Channels - Tapped

Mounting Channels

RU Height	MCX Mounting Channels-M6	MCX Mounting Channels-Tapped
	45	MCX-TN-S-45U-PLT
40	MCX-TN-S-40U-PLT	MCX-TN-T-40U-PLT
35	MCX-TN-S-35U-PLT	MCX-TN-T-35U-PLT

Top Panels



Solid w/o Cable Egress Ports



Solid



Vented



BTA4 Fan



BTA6 Fan



BTA10 Fan

24" Width Top Panels

Frame Depth	Solid w/o Cable Egress Ports	Solid	Vented	BTA4 Fan	BTA6 Fan	BTA10 Fan
36"	TP-TN-2436	TP-AFS-24-36	TP-AFV-24-36	TPF4-TN-2436	TPF6-TN-2436	TPF10-TN-2436
30"	TP-TN-2430	TP-AFS-24-30	TP-AFV-24-30	TPF4-TN-2430	TPF6-TN-2430	TPF10-TN-2430
25.5"	TP-TN-2425	TP-AFS-24-255	TP-AFV-24-25	TPF4-TN-2425	TPF6-TN-2425	TPF10-TN-2425



Titan ZN4 - Electronics Packaging

Doors



Curved Face

Vented Flush

Vented Face

24" Width Curved-Face Door - New Design!

RU Height	Polycarbonate	Solid	Vented
45	DK-CP-45U24	DK-CS-45U24	DK-CV-45U24
40	DK-CP-40U24	DK-CS-40U24	DK-CV-40U24
35	DK-CP-35U24	DK-CS-35U24	DK-CV-35U24

24" Width Square-Face Door

RU Height	Polycarbonate	Solid	Vented	Louvered
45	DPFA-TN-45U24	DSFA-TN-45U24	DVFA-TN-45U24	DLFA-TN-45U24
40	DPFA-TN-40U24	DSFA-TN-40U24	DVFA-TN-40U24	DLFA-TN-40U24
35	DPFA-TN-35U24	DSFA-TN-35U24	DVFA-TN-35U24	DLFA-TN-35U24

24" Width Flush Door

RU Height	Polycarbonate	Solid	Vented	Louvered
45	DPFL-TN-45U24	DSFL-TN-45U24	DVFL-TN-45U24	DLFL-TN-45U24
40	DPFL-TN-40U24	DSFL-TN-40U24	DVFL-TN-40U24	DLFL-TN-40U24
35	DPFL-TN-35U24	DSFL-TN-35U24	DVFL-TN-35U24	DLFL-TN-35U24

Side Panels



Louvered Side Panel

Side Panel

Side Panel

RU Height	25.5" Depth	30" Depth	36" Depth*
45	SPKS-45U-255	SPKS-45U-30	SPKS-45U-36
40	SPKS-40U-255	SPKS-40U-30	SPKS-40U-36
35	SPKS-35U-255	SPKS-35U-30	SPKS-35U-36

Louvered Side Panel

RU Height	25.5" Depth	30" Depth	36" Depth*
45	SPKL-45U-255	SPKL-45U-30	SPKL-45U-36
40	SPKL-40U-255	SPKL-40U-30	SPKL-40U-36
35	SPKL-35U-255	SPKL-35U-30	SPKL-35U-36

Note: Side panels are available in bolt down version - specify at time of order placement.
 *36" depth side panels have two locks at the top vs. the 25.5" and 30" depth

Door Features



Swing handle with lock
 Secures valuable equipment



Combination handle (H907)
 Optional handle with keyed lock



Vented pattern
 77% open pattern



Titan ZN4 - Electronics Packaging

Enclosure Panels



Solid Full-Length
Louvered Full-Length



Solid Louvered

Full-Length Enclosure Panels - Formed

RU Height	Solid	Louvered
45	RPS-TN-45U24	RPL-TN-45U24
40	RPS-TN-40U24	RPL-TN-40U24
35	RPS-TN-35U24	RPL-TN-35U24

Enclosure Panels - Formed

RU Height	Solid	Louvered
6	EPS-TN-6U24	EPL-TN-6U24
5	EPS-TN-5U24	EPL-TN-5U24
4	EPS-TN-4U24	EPL-TN-4U24
3	EPS-TN-3U24	EPL-TN-3U24
2	EPS-TN-2U24	EPL-TN-2U24
1	EPS-TN-1U24	EPL-TN-1U24

Blanking Panels



Solid Blanking Panels - Steel

UA-BPS1 UA-BPS4
UA-BPS2 UA-BPS5
UA-BPS3



Vented Blanking Panels - Steel

UA-BPHS1 UA-BPHS4
UA-BPHS2 UA-BPHS5
UA-BPHS3



Flat Blanking Panels - Aluminum

FBP1 FBP4
FBP2 FBP5
FBP3 FBP6

Cooling



Fan Stack

Fan Stack

Part Number	CFM (total)	DB	Voltage	# of Fans	Fan Dia.	Depth
UA-FS1-S8	120	27	115	2	4.75"	8"
UA-FS1-S14	120	27	115	2	4.75"	14"



Fan Panel With Display

Fan Panel With Display

Part Number	CFM (total)	DB	Voltage	# of Fans	Fan Dia.	Rack Height
UA-QFD2-2	50	28	115	2	3"	2RU
UA-QFD2-4	100	28	115	4	3"	2RU
UA-QFD3-2	120	27	115	2	4.75"	3RU



Fan Panel Without Display

Fan Panel Without Display

Part Number	CFM (total)	DB	Voltage	# of Fans	Fan Dia.	Rack Height
UA-QF2-2	50	28	115	2	3"	2RU
UA-QF2-4	100	28	115	4	3"	2RU
UA-QF3-2	120	27	115	2	4.75"	3RU



Titan ZN4 - Electronics Packaging

Shelves

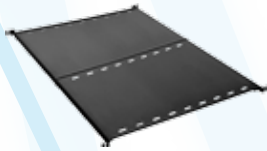

Adjustable Solid
UA-SHAS-1725 (17" - 25")
UA-SHAS-2540 (25" - 40")
(300 lb load rating)

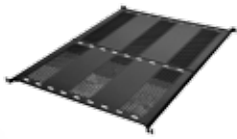

Adjustable Vented
UA-SHAV-1725 (17" - 25")
UA-SHAV-2540 (25" - 40")
(300 lb load rating)



Retractable Solid
SHRS-TN-1U24
SHRS-TN-1U29
(100 lb load rating)



Retractable Vented
SHRV-TN-1U24
SHRV-TN-1U29
(100 lb load rating)

Heavy Duty Retractable Solid
SHRS-TN-2U24-HD
SHRS-TN-2U29-HD
(250 lb load rating)

Heavy Duty Retractable Vented
SHRV-TN-2U24-HD
SHRV-TN-2U29-HD
(250 lb load rating)

Casters



Light Duty Caster
CA-C175
(175 lb load rating)



Heavy Duty Caster
CA-C1200
(1200 lb load rating)

Lacing Bars



Lacing Bar "C" Style
UA-LB2 (2" depth)
UA-LB4 (4" depth)
UA-LB6 (6" depth)



Lacing Bar Straight Style
UA-LB3



Round Lacing Bar
UA-LBR2

Adjustable Chassis Guides

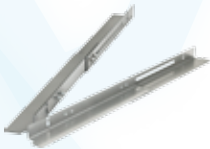

Chassis Guides
CHGA-TN-2536
(25"-36" Depths)
(125 lb load rating)

Busbar



Busbar
BB-TN-30U
BB-TN-35U
BB-TN-40U

Drawers

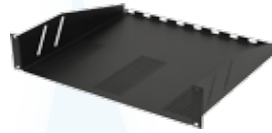

Vented Light Duty Shelf
UA-SH1 (15 lb load rating)
UA-SH2 (50 lb load rating)
UA-SH3 (60 lb load rating)
UA-SH4 (70 lb load rating)
UA-SH5 (80 lb load rating)

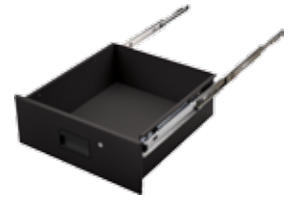

Heavy Duty Drawer With Lock
DR-TN-2U24-20
DR-TN-4U24-20
(150 lb load rating)

Horizontal Cable Management

HCM Panels have a 2RU panel height (3.50") and feature 10 ga. steel construction. Available in 4" and 7" depths.



HCM4 - 4" Depth
HCM7- 7" Depth

Vertical Cable Management

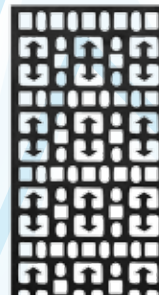

Cable Lacing Strip

Cable Lacing Strip

RU Height	5" Width
45	CLS-45U-5
40	CLS-40U-5
35	CLS-35U-5

Hardware



Joining Kit
HK-R-TN



Dzus M6
HKDZ-25



10-32 Hardware Kit
HKEP1032-25



Hardware Kit
HK500



Hardware Kit
T441



Cable Ring Kit
HK-CR1



M6
HKM6-25



Hilti™ Bolt Anchoring Kit
TN-Z4-BDK-12
4 pcs.

Titan ZN4 - Electronics Packaging

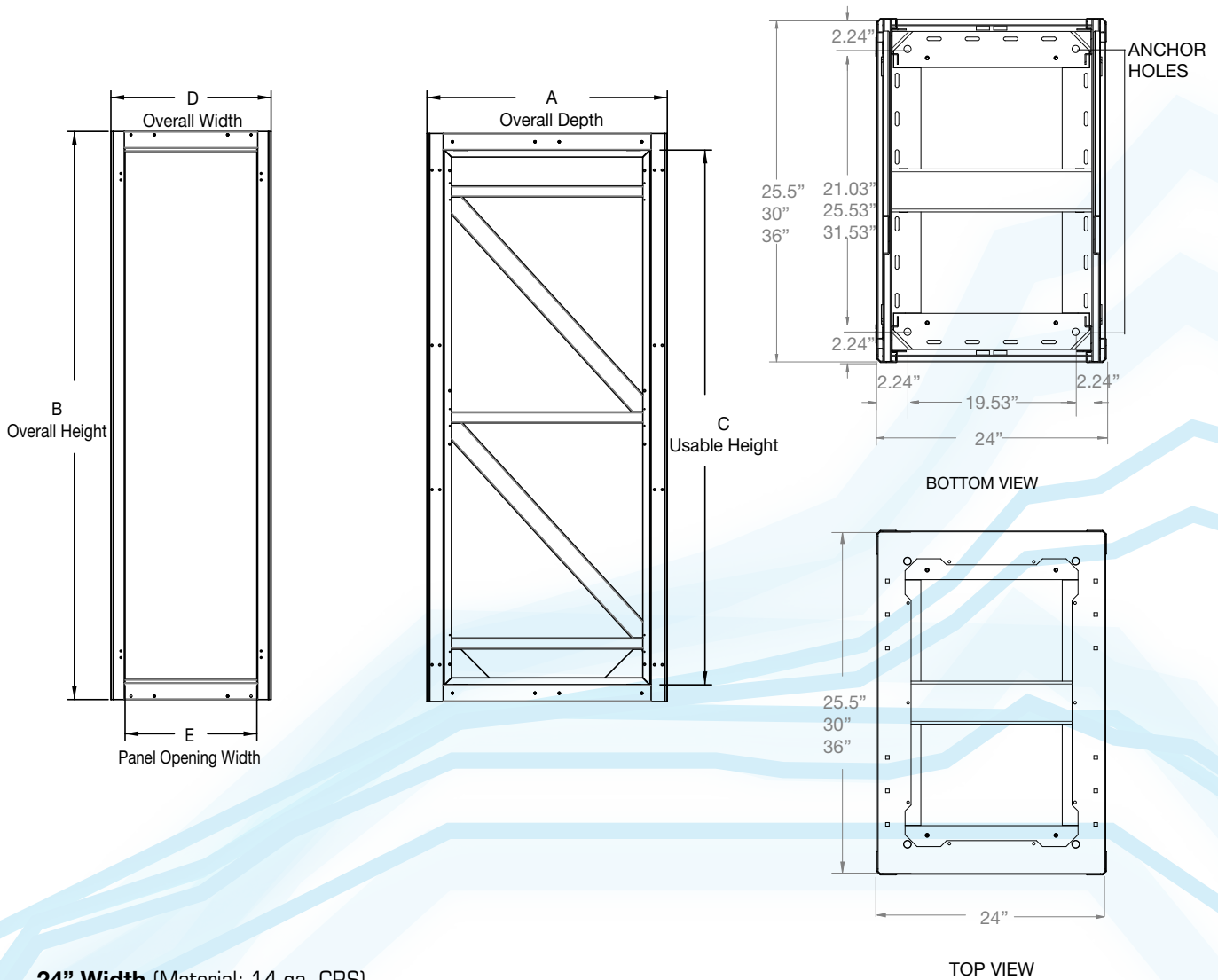

24" Width (Material: 14 ga. CRS)

RU Height	25.5" Depth (A) (23.25" usable)	30" Depth (A) (27.75" usable)	36" Depth (A) (33.75" usable)	Overall Height (B)	Usable Height (C)	Overall Width (D)	Panel Opening Width (E)
45	R-Z4-45U24-255	R-Z4-45U24-30	R-Z4-45U24-36	85.12"	78.75"	24"	19.75"
40	R-Z4-40U24-255	R-Z4-40U24-30	R-Z4-40U24-36	76.37"	70.0"	24"	19.75"
35	R-Z4-35U24-255	R-Z4-35U24-30	R-Z4-35U24-36	67.62"	61.25"	24"	19.75"

Test results are available and supplied upon request.



AMCO's Test Report



AMCO Enclosures Titan ZN4 Series
www.amcoenclosures.com - 847-391-8100

Titan ZN4 - Electronics Packaging

Technical - Doors

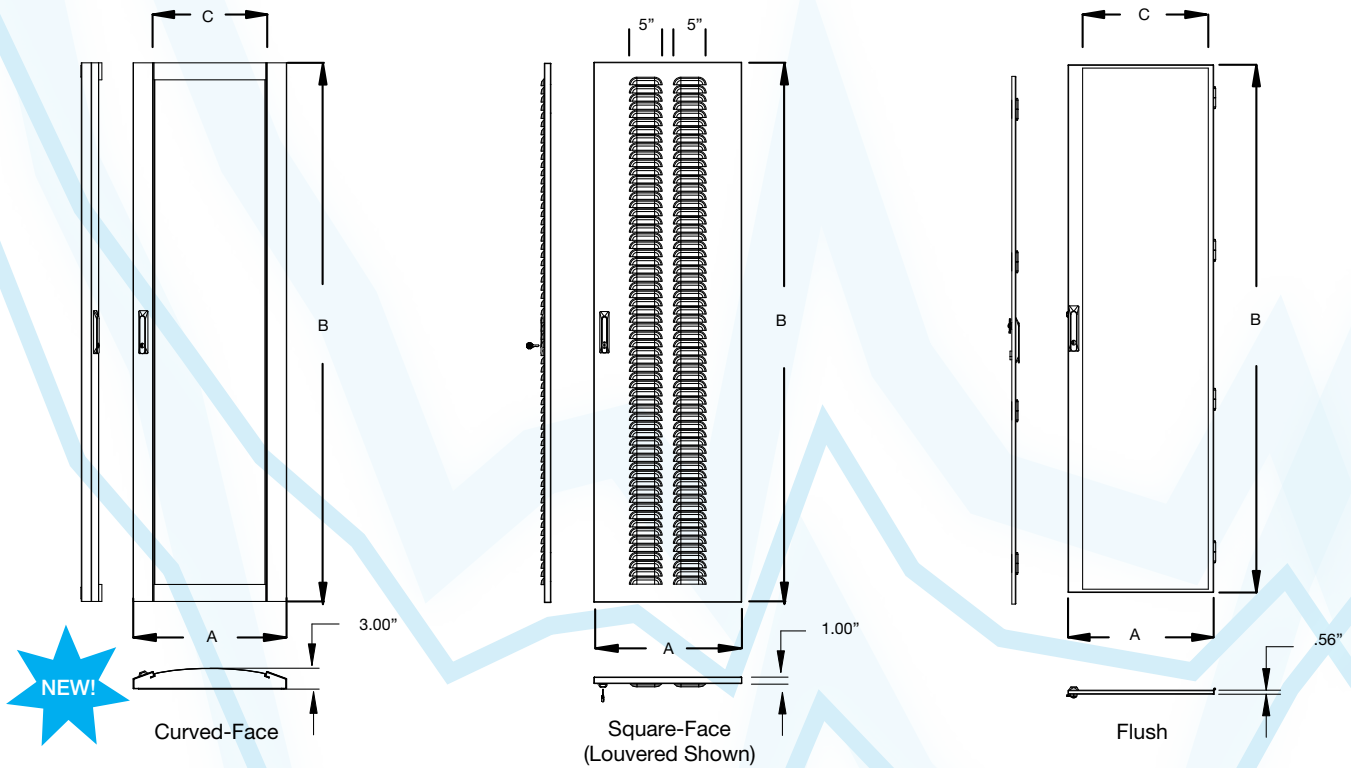

24" Width Curved-Face (Material: 18 ga. CRS)

RU Height	Polycarbonate	Solid	Vented	Width (A)	Height (B)	Panel Opening (C)
45	DK-CP-45U24	DK-CS-45U24	DK-CV-45U24	22.56"	82.44"	16.21"
40	DK-CP-40U24	DK-CS-40U24	DK-CV-40U24	22.56"	73.69"	16.21"
35	DK-CP-35U24	DK-CS-35U24	DK-CV-35U24	22.56"	64.94"	16.21"

24" Width Square-Face (Material: 18 ga. CRS)

RU Height	Polycarbonate	Solid	Vented	Louvered	Width (A)	Height (B)
45	DPFA-TN-45U24	DSFA-TN-45U24	DVFA-TN-45U24	DLFA-TN-45U24	22.56"	82.44"
40	DPFA-TN-40U24	DSFA-TN-40U24	DVFA-TN-40U24	DLFA-TN-40U24	22.56"	73.69"
35	DPFA-TN-35U24	DSFA-TN-35U24	DVFA-TN-35U24	DLFA-TN-35U24	22.56"	64.94"

24" Width Flush (Material: 18 ga. CRS)

RU Height	Polycarbonate	Solid	Vented	Louvered	Width (A)	Height (B)	Panel Opening (C)
45	DPFL-TN-45U24	DSFL-TN-45U24	DVFL-TN-45U24	DLFL-TN-45U24	19.53"	79.87"	14.04"
40	DPFL-TN-40U24	DSFL-TN-40U24	DVFL-TN-40U24	DLFL-TN-40U24	19.53"	71.12"	14.04"
35	DPFL-TN-35U24	DSFL-TN-35U24	DVFL-TN-35U24	DLFL-TN-35U24	19.53"	62.37"	14.04"



Titan ZN4 - Electronics Packaging

Technical - Top Panels

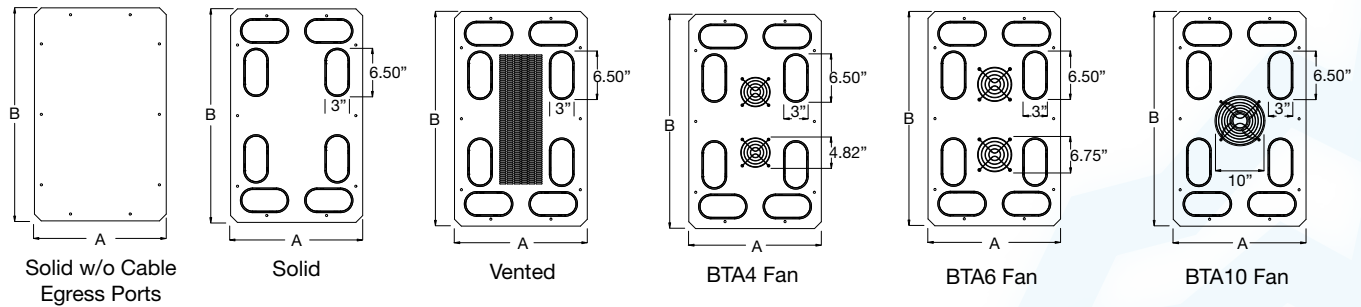

24" Width Top Panels (Material: 16 ga. CRS)

Solid w/o Cable Egress Ports	Solid	Vented	BTA6 Fan	BTA10 Fan	Width (A)	Depth (B)
TP-TN-2436	TP-AFS-24-36	TP-AFV-24-36	TPF6-TN-2436	TPF10-TN-2436	19.46"	31.47"
TP-TN-2430	TP-AFS-24-30	TP-AFV-24-30	TPF6-TN-2430	TPF10-TN-2430	19.46"	25.47"
TP-TN-2425	TP-AFS-24-255	TP-AFV-24-255	TPF6-TN-2425	TPF10-TN-2425	19.46"	20.97"

Technical - Mounting Channels

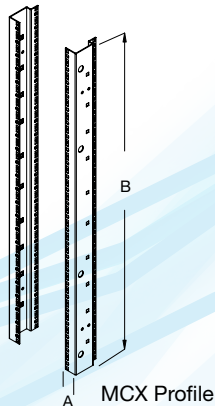

MCX Profile (Material: 14 ga. CRS)

RU Height	M6 Part Number	#10-32 Part Number (Tapped)	Width (A)	Height (B)
45	MCX-TN-S-45U-PLT	MCX-TN-T-45U-PLT	1.56"	82.31"
40	MCX-TN-S-40U-PLT	MCX-TN-T-40U-PLT	1.56"	77.06"
35	MCX-TN-S-35U-PLT	MCX-TN-T-35U-PLT	1.56"	73.56"

Technical - Side Panels

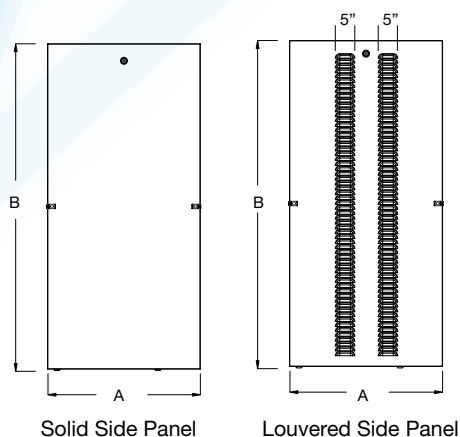

Solid Side Panel (Material: 18 ga. CRS)

RU Height	25.5" Depth (A 20.29")	30" Depth (A 24.79")	36" Depth* (A 30.79")	Overall Height (B)
45	SPKS-45U-255	SPKS-45U-30	SPKS-45U-36	80"
40	SPKS-40U-255	SPKS-40U-30	SPKS-40U-36	71.25"
35	SPKS-35U-255	SPKS-35U-30	SPKS-35U-36	62.5"

Louvered Side Panel (Material: 18 ga. CRS)

RU Height	25.5" Depth (A 20.29")	30" Depth (A 24.79")	36" Depth* (A 30.79")	Overall Height w(B)
45	SPKL-45U-255	SPKL-45U-30	SPKL-45U-36	80"
40	SPKL-40U-255	SPKL-40U-30	SPKL-40U-36	71.25"
35	SPKL-35U-255	SPKL-35U-30	SPKL-35U-36	62.5"

*36" depth side panels have two locks at the top.



Titan ZN4 - Electronics Packaging

Technical - Enclosure Panels

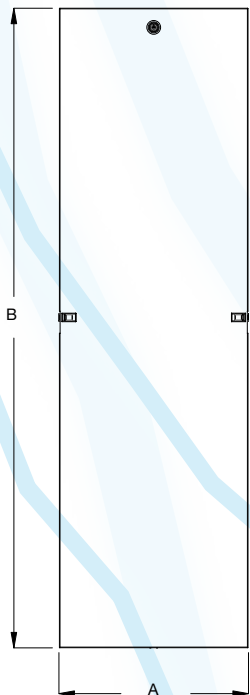

Solid Full-Length Enclosure Panel

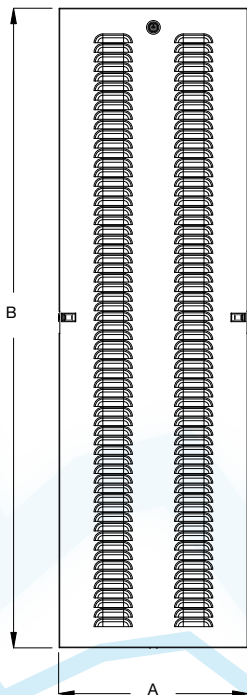

Louvered Full-Length Enclosure Panel

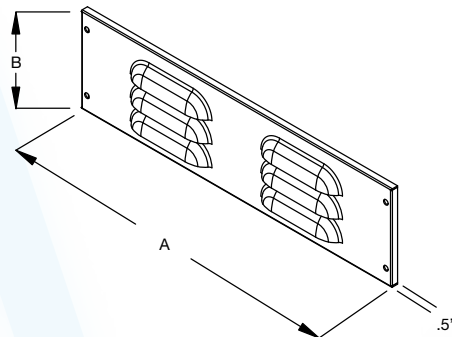

Louvered Enclosure Panel

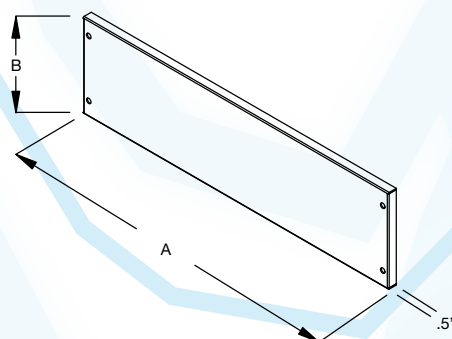

Solid Enclosure Panel

24" Width Full-Length Enclosure Panel (Material: 16 ga. CRS)

RU Height	Solid	Louvered	Overall Width (A)	Overall Height (B)
45	RPS-TN-45U24	RPL-TN-45U24	19.63"	80"
40	RPS-TN-40U24	RPL-TN-40U24	19.63"	71.25"
35	RPS-TN-35U24	RPL-TN-35U24	19.63"	62.5"

24" Width Enclosure Panel (Material: 16 ga. CRS)

RU Height	Solid	Louvered	Width (A)	Height (B)
6	EPS-TN-6U24	EPL-TN-6U24	19.00"	10.5"
5	EPS-TN-5U24	EPL-TN-5U24	19.00"	8.75"
4	EPS-TN-4U24	EPL-TN-4U24	19.00"	7.00"
3	EPS-TN-3U24	EPL-TN-3U24	19.00"	5.25"
2	EPS-TN-2U24	EPL-TN-2U24	19.00"	3.5"
1	EPS-TN-1U24	EPL-TN-1U24	19.00"	1.75"

Technical - Formed Blanking Panels

Formed Blanking Panels (Material: 0.64 Aluminum)

RU Height	Formed	Width (A)	Overall Height (B)
1	FBP1	19	1.72
2	FBP2	19	3.47
3	FBP3	19	5.22
4	FBP4	19	6.97
5	FBP5	19	8.72
6	FBP6	19	10.47

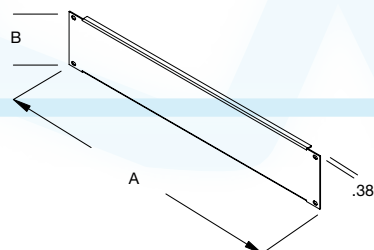

Formed Blanking Panel



Titan ZN4 - Electronics Packaging

Technical - Accessories

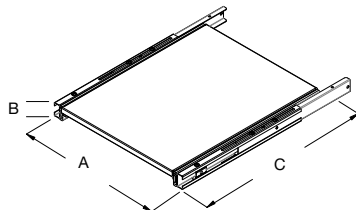

Shelf - Solid Retractable

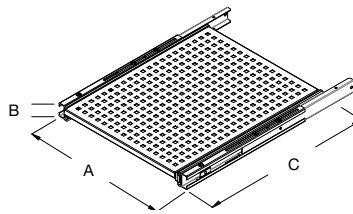

Shelf - Vented Retractable

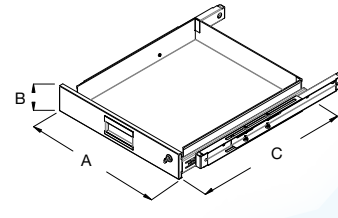

Heavy Duty Drawer

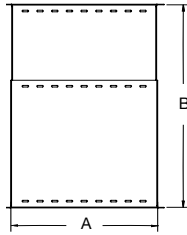

Heavy Duty Adjustable Shelf - Solid



Heavy Duty Adjustable Shelf - Vented

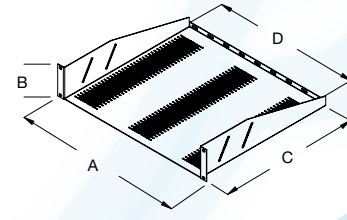

Light Duty Shelf Vented

Heavy Duty Drawer (Material: 14 ga. CRS)

Part Number	RU Height	Overall Width (A)	Height (B)	Depth (C)	Load Rating
DR-TN-4U24-20	4	18.93"	7"	20.5"	150 lb
DR-TN-2U24-20	2	18.93"	3.5"	20.5"	150 lb

Heavy Duty Retractable Shelves - Solid/Vented (Material: 14 ga. CRS)

Solid	Vented	Width (A)	Overall Height (B)	Depth (C)	Load Rating
SHRS-TN-1U24	SHRV-TN-1U24	16.81"	1.75"	22"	150 lb
SHRS-TN-1U29	SHRV-TN-1U29	21.81"	1.75"	22"	150 lb

24" Width Heavy Duty Adjustable Shelves - Solid/Vented (Material: 14 ga. CRS)

Solid	Vented	Width (A)	Height	Depth (B)	Load Rating
UA-SHAS-2540-24	UA-SHAV-2540-24	17.6"	1.75"	25" - 40"	300 lb
UA-SHAS-1725-24	UA-SHAV-1725-24	17.6"	1.75"	17" - 25"	300 lb

Light Duty Shelf Vented (Material: 16 ga. CRS)

Vented	Width (A)	Height (B)	Depth (C)	Usable Width (D)	Load Rating
UA-SH5	19.00"	8.75"	16.08"	17.375"	80 lb
UA-SH4	19.00"	7.00"	16.08"	17.375"	70 lb
UA-SH3	19.00"	5.25"	16.08"	17.375"	60 lb
UA-SH2	19.00"	3.50"	16.08"	17.375"	50 lb
UA-SH1	19.00"	1.75"	16.08"	17.375"	15 lb

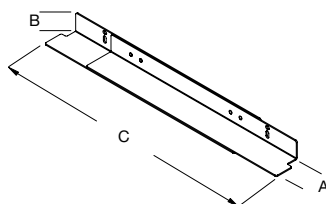

Adjustable Chassis Guides (Material: 12 ga. CRS)

Part Number	Width (A)	Height (B)	Depth (C)	Load Rating
CHGA-TN-2536	3"	1.75"	25"-36"	125 lb



Titan ZN4 - Electronics Packaging

Technical - Hilti™ Bolt Anchorage & Frame Joining Kits

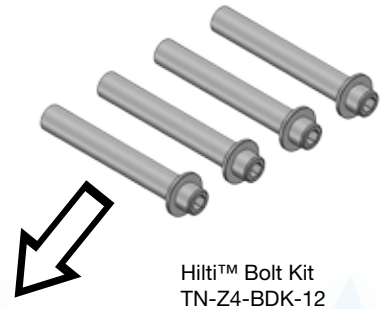
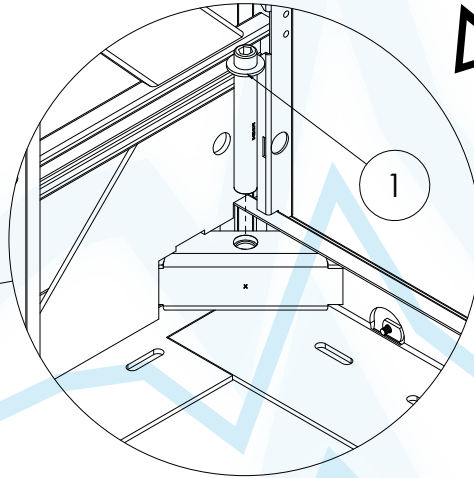
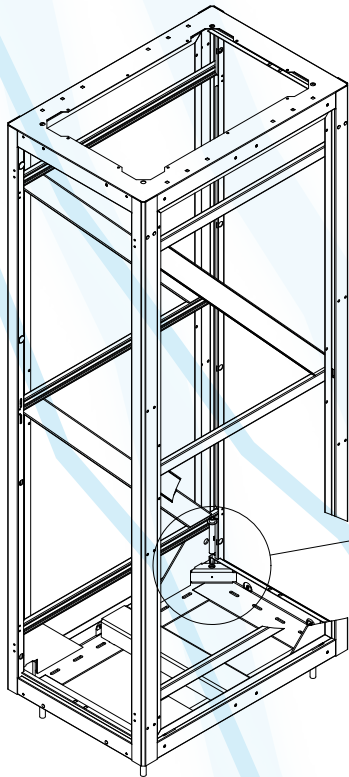

Hilti™ Bolt Kit
TN-Z4-BDK-12

Joining Kit
HK-R-TN

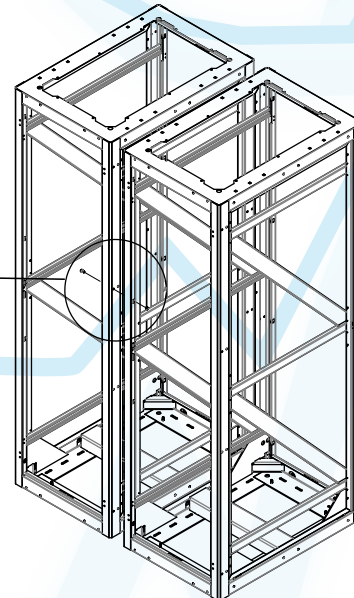
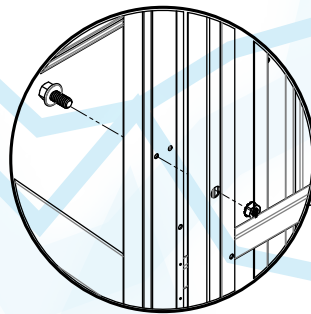

Titan ZN4 racks can be joined together with simple hardware to form multi-bay consoles. No complex joining systems or structures are required; simple nut and bolt hardware makes multiple-bay joining fast and easy.



Titan ZN4 - Data

Certified to Telcoredia Specification NEBS GR-63-CORE 4.4
1,200 LB SEISMIC LOAD RATING

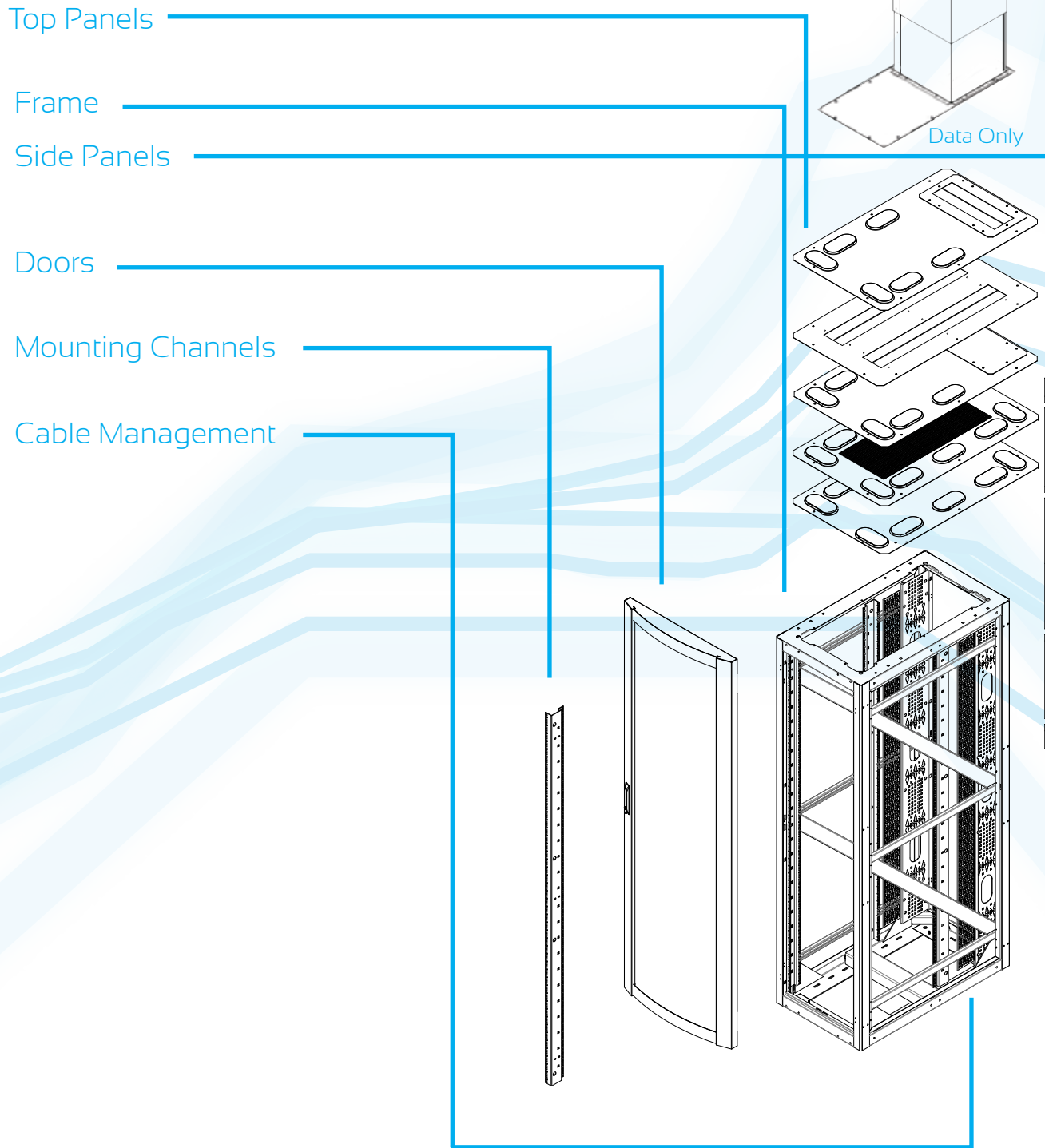

Titan ZN4 - Data

Titan DT vertical frames are available in the following sizes:

Panel Heights: 42RU, 44RU and 47RU

Frame widths: 24"

Frame depths: 36" and 42"

Other sizes available and quoted upon request

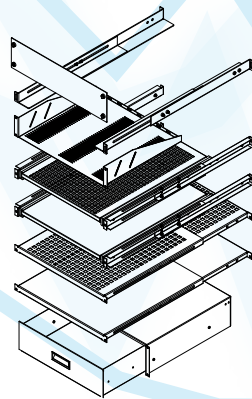
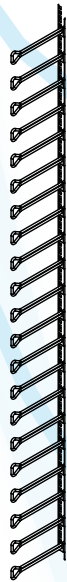
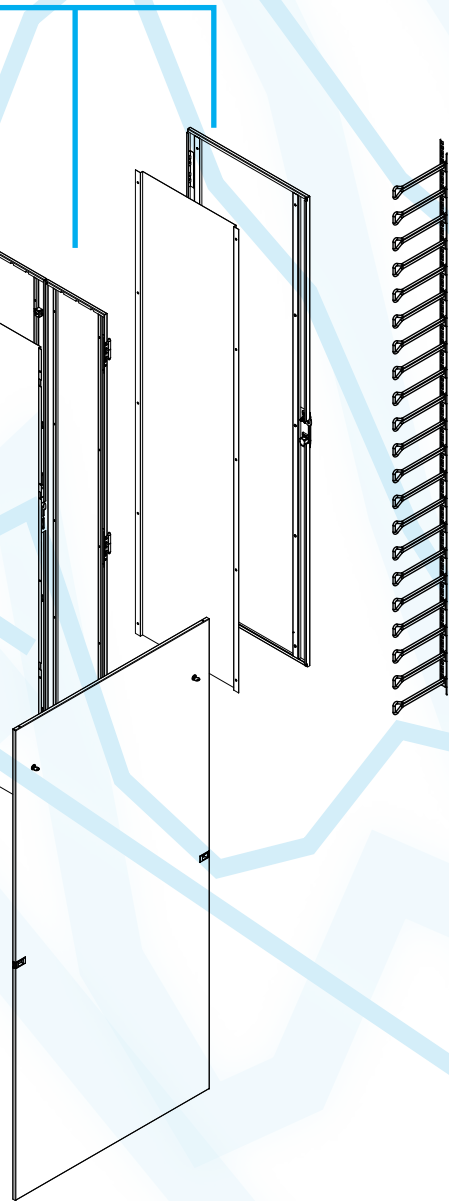

Accessories



For more product information on specific parts,
please see AMCO Enclosures' TitanDT catalog.



AMCO Enclosures Titan ZN4 Series
www.amcoenclosures.com - 847-391-8100

Titan ZN4 - Data

AMCO Enclosures has designed its NEBS GR-63-CORE Titan ZN4 cabinets to be as easily configurable as its other enclosure series—allowing an almost infinite amount of flexibility in your accessory selection. Doors, side and top panels, cable management—all can be selected to expand the frame's adaptation to each specific design requirement.

Frames



24" Width Frames
19" Panel Opening

24" Width Frames

RU Height	42" Depth
47	R-Z4-47U24-42
44	R-Z4-44U24-42
42	R-Z4-42U24-42

RU Height	36" Depth
47	R-Z4-47U24-36
44	R-Z4-44U24-36
42	R-Z4-42U24-36

Note: Mounting channels not included.

Overhead Chimney Solution



Top Duct Exhaust Kit
(35" - 60")



Top Duct Exhaust Kit
(20" - 35")

20" - 35" Height

24" Width
TP-AFD3-24-42
TP-AFD3-24-36

35" - 60" Height

24" Width
TP-AFD6-24-42
TP-AFD6-24-36

Part number includes top panel without cover plate air deflector and top duct exhaust.

Top Panels



Solid



Vented



Brush Strip



Dual Brush Strip



Cover Plate

24" Width Top Panels

Frame Depth	Solid	Vented	Brush Strip	Dual Brush Strip	Cover Plate
42"	TP-AFS-24-42	TP-AFV-24-42	TP-AFB-24-42	TP-AFDB-24-42	TP-AFC-24-42
36"	TP-AFS-24-36	TP-AFV-24-36	TP-AFB-24-36	TP-AFDB-24-36	TP-AFC-24-36



Titan ZN4 - Data

Doors



24" Width Curved-Face Door - New Design!

RU Height	Vented
47	DK-CV-47U24
44	DK-CV-44U24
42	DK-CV-42U24

24" Width French Flush

RU Height	Vented	Door with Solid Insert
47	DFK-BFZ-47U24	DFK-BFZ-SPI-47U24
44	DFK-BFZ-44U24	DFK-BFZ-SPI-44U24
42	DFK-BFZ-42U24	DFK-BFZ-SPI-42U24

24" Width Flush Door

RU Height	Vented w/ Solid Insert	Vented
47	DSFL-TN-47U24	DVFL-TN-47U24
44	DSFL-TN-44U24	DVFL-TN-44U24
42	DSFL-TN-42U24	DVFL-TN-42U24

Mounting Channels



MX Mounting Channels

Mounting Channels

RU Height	MCX Mounting Channels-M6
47	MCX-TN-S-47U
44	MCX-TN-S-44U
42	MCX-TN-S-42U

Door Features



Swing handle with lock
Secures valuable equipment



Combination handle (H907)
Optional handle with keyed lock

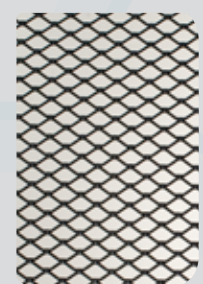

Vented pattern
77% open pattern

Flush Door Solid Inserts

TitanDT vented flush doors can be expanded as thermal requirements for your racks change. Solid cover panels are available to convert front-to-rear (hot aisle) cooling to an overhead duct design. Simply add the solid cover panels beneath the existing screens.

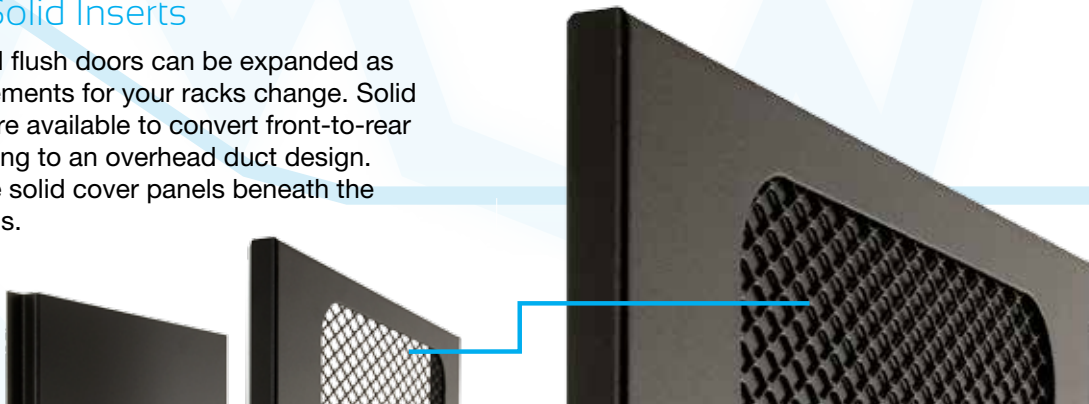

Titan ZN4 - Data

Side Panels



Side Panel

Side Panel

RU Height	36" Depth	42" Depth
47	SPKS-47U-36	SPKS-47U-42
44	SPKS-44U-36	SPKS-44U-42
42	SPKS-42U-36	SPKS-42U-42

Note: Side panels are available in bolt-down version - specify at time of order placement.

Drawers



Drawer With Lock

UA-DR2-LK (30 lb load rating)
 UA-DR3-LK (40 lb load rating)
 UA-DR4-LK (50 lb load rating)

Shelves

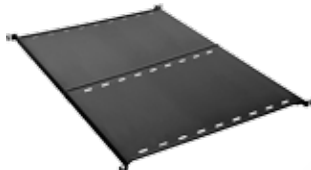

Heavy Duty Adjustable Solid
 UA-SHAS-2540 (25"- 40")
 (300 lb load rating)

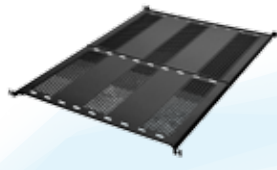

Heavy Duty Adjustable Vented
 UA-SHAV-2540 (25"- 40")
 (300 lb load rating)

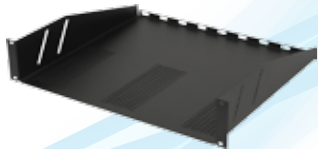

Vented Light Duty Shelf
 UA-SH1 (15 lb load rating)
 UA-SH2 (50 lb load rating)
 UA-SH3 (60 lb load rating)
 UA-SH4 (70 lb load rating)
 UA-SH5 (80 lb load rating)

Lacing Bars



Lacing Bar "C" Style

UA-LB2 (2" depth)
 UA-LB4 (4" depth)
 UA-LB6 (6" depth)



Lacing Bar Straight Style

UA-LB3



Round Lacing Bar

UA-LBR2

Tool-less Blanking Panels



Steel Blanking Panels

RU Height	Steel Panel Part Number
1RU	BPT24-1U
2RU	BPT24-2U
3RU	BPT24-3U
4RU	BPT24-4U
8RU	BPT24-8U

- Tool-less
- Cover empty spaces in panel openings
- Optimize air circulation



Co-Poly Blanking Panels

(with 6 ea. 1RU panels)
 Square hole only

RU Height	Co-Poly Panel Part Number
6RU	BP-6U-P

Casters



Light Duty Caster
 CA-C175
 (175 lb load rating each)



Heavy Duty Caster
 CA-C1200
 (1200 lb load rating each)

Adjustable Chassis Guides



CHGA-TN-2536-D
 (25" to 36" Depths)
 (125 lb load rating)



Titan ZN4 - Data

Vertical Finger Bracket Kit

The finger bracket kit mounts to the side of the rack and accepts large bundle drops of cabling between frames, routing to vertical cable managers that distribute the cabling to 1RU or 2RU sections of patch panels. Sold in pairs.

Vertical Finger Bracket Kit -1RU & 2RU

RU Height	1 RU	2 RU
47	VFBK-47U-1	VFBK-47U-2
44	VFBK-44U-1	VFBK-44U-2
42	VFBK-42U-1	VFBK-42U-2

Choose between 1RU or 2RU Finger Brackets

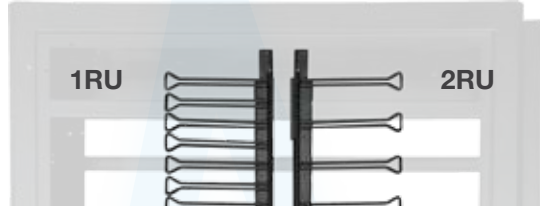

Vertical Cable Management



Power/Cable Panel

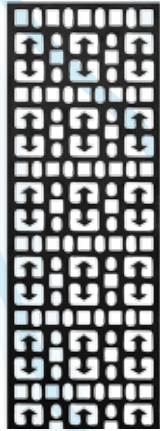

Cable Lacing Strip

Power/Cable Panel

RU Height	7" Width
47	PCP-47U-7
44	PCP-44U-7
42	PCP-42U-7

Cable Lacing Strip

RU Height	5" Width
47	CLS-47U-5
44	CLS-44U-5
42	CLS-42U-5

Horizontal Cable Management

HCM Panels have a 2RU panel height (3.50") and feature 10 ga. steel construction. Available in 4" and 7" depths.



HCM4 - 4" Depth
HCM7- 7" Depth

Hardware



M6
HKM6-25



Dzus M6
HKDZ-25



Hardware Kit
T441



Cable Ring Kit
HK-CR1



10-32 Hardware Kit
HKEP1032-25



Hardware Kit
HK500



Joining Kit
HK-R-TN

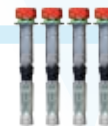

Hilti™ Bolt Anchoring Kit
TN-Z4-BDK-12
4 pcs.



Titan ZN4 - Data

Technical - Frame

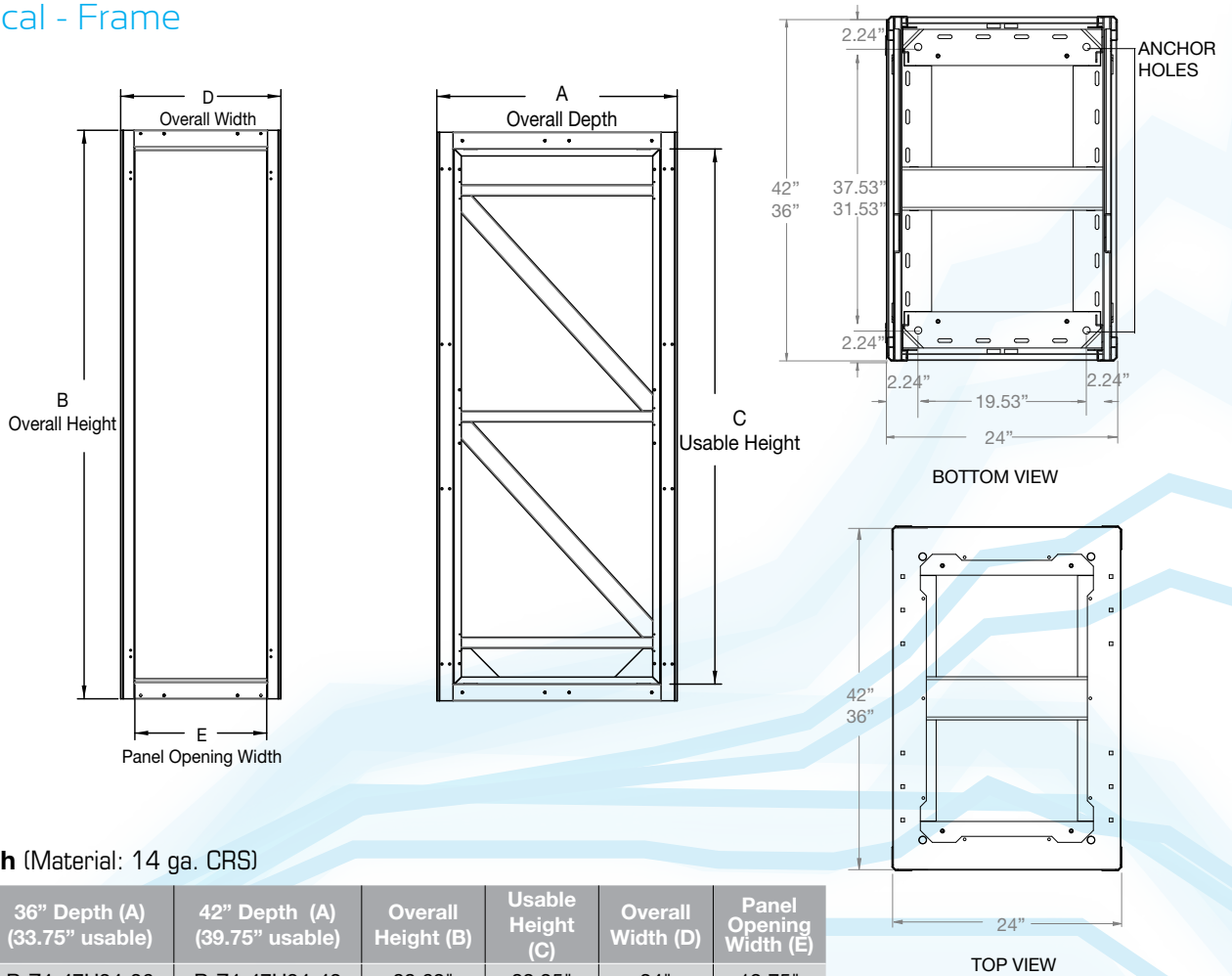

24" Width (Material: 14 ga. CRS)

RU Height	36" Depth (A) (33.75" usable)	42" Depth (A) (39.75" usable)	Overall Height (B)	Usable Height (C)	Overall Width (D)	Panel Opening Width (E)
47	R-Z4-47U24-36	R-Z4-47U24-42	88.62"	82.25"	24"	19.75"
44	R-Z4-44U24-36	R-Z4-44U24-42	83.37"	77"	24"	19.75"
42	R-Z4-42U24-36	R-Z4-42U24-42	79.87"	73.5"	24"	19.75"

Technical - Top Panels

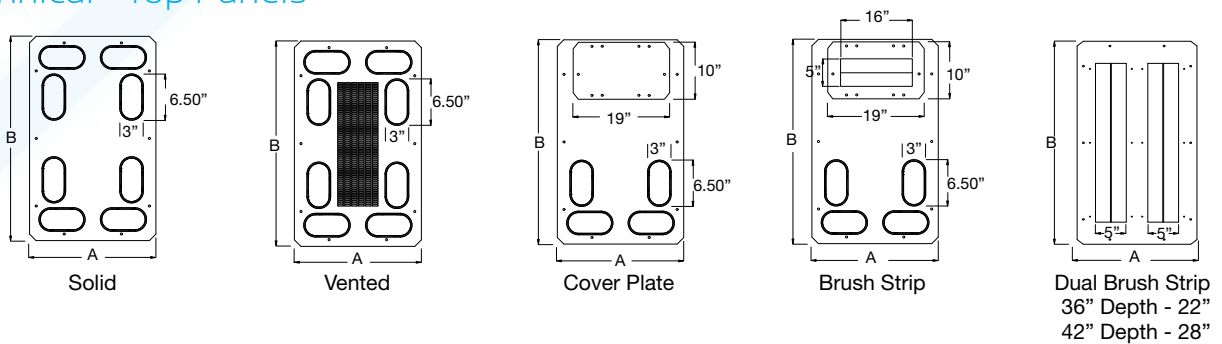

24" Width (Material: 16 ga. CRS)

Solid	Vented	Cover Plate	Brush Strip	Dual Brush Strip	Width (A)	Depth (B)
TP-AFS-24-42	TP-AFV-24-42	TP-AFC-24-42	TP-AFB-24-42	TP-AFDB-24-42	19.46"	37.46"
TP-AFS-24-36	TP-AFV-24-36	TP-AFC-24-36	TP-AFB-24-36	TP-AFDB-24-36	19.46"	31.46"



Titan ZN4 - Data

Technical - Doors

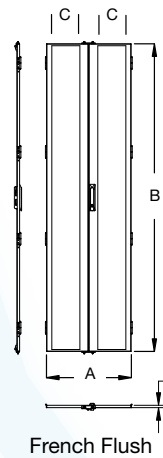
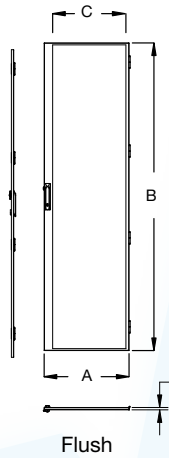

Curved-Face (Material: 18 ga. CRS)

RU Height	Vented	Width (A)	Height (B)	Panel Opening (C)
47	DK-CV-47U24	22.56"	85.93"	18"
44	DK-CV-44U24	22.56"	80.68"	18"
42	DK-CV-42U24	22.56"	77.18"	18"

Flush (Material: 18 ga. CRS)

RU Height	Solid Insert	Vented	Width (A)	Height (B)	Panel Opening (C)
47	DK-BFS-47U24	DK-BFZ-47U24	19.53"	83.37"	14.04"
44	DK-BFS-44U24	DK-BFZ-44U24	19.53"	78.12"	14.04"
42	DK-BFS-42U24	DK-BFZ-42U24	19.53"	71.12"	14.04"

Note: Solid inserts fit within the "C" dimensions of the flush flat and french doors.

French Flush (Material: 18 ga. CRS)

RU Height	Solid Insert	Vented	Width (A)	Height (B)	Panel Opening (C)
47	DFK-BFS-47U24	DFK-BFZ-47U24	19.53"	83.37"	9.68"
44	DFK-BFS-44U24	DFK-BFZ-44U24	19.53"	78.12"	9.68"
42	DFK-BFS-42U24	DFK-BFZ-42U24	19.53"	71.12"	9.68"

Technical - Overhead Chimney

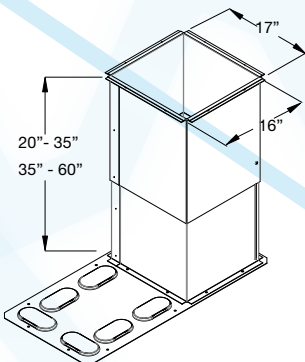

20" - 35"

35" - 60"

24" Width	24" Width
TP-AFD3-24-42	TP-AFD6-24-42
TP-AFD3-24-36	TP-AFD6-24-36

Part number includes top panel without cover plate air deflector and top duct exhaust.

Overhead Chimney Solution
14 gauge Aluminum (.064" Thickness)



Titan ZN4 - Data

Technical - Mounting Channels

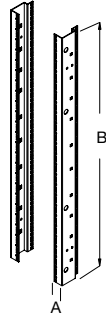

MCX Profile

MCX Profile-M6 (Material: 14 ga. CRS)

RU Height	Part Number	Width (A)	Height (B)
47	MCX-TN-S-47U	1.56"	82.31"
44	MCX-TN-S-44U	1.56"	77.06"
42	MCX-TN-S-42U	1.56"	73.56"

Technical - Side Panels

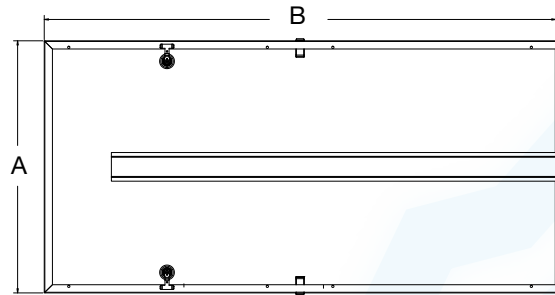

Side Panel (Material: 18 ga. CRS)

RU Height	36" Depth (A 30.79")	42" Depth (A 36.79")	Overall Height (B)
47	SPKS-47U-36	SPKS-47U-42	83.5"
44	SPKS-44U-36	SPKS-44U-42	78.25"
42	SPKS-42U-36	SPKS-42U-42	74.75"

Technical - Shelves and Drawers

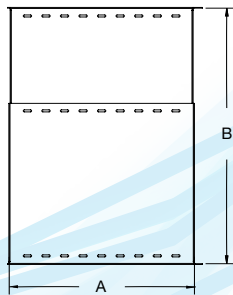

Heavy Duty Shelf - Solid

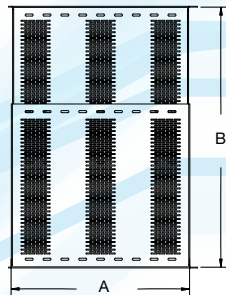

Heavy Duty Shelf - Vented

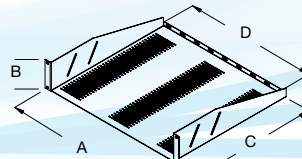

Light Duty Shelf

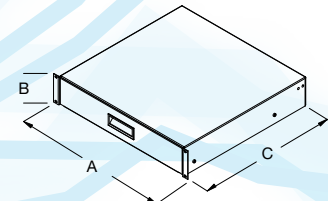

Drawer

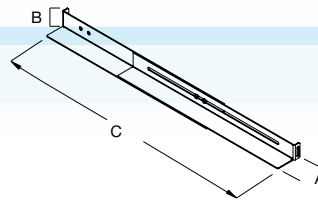

Adjustable Chassis Guides

Heavy Duty Adjustable Shelves (Material: 14 ga. CRS)

Solid	Vented	Width (A)	Height	Depth (B)	Load Rating
UA-SHAS-2540	UA-SHAV-2540	19"	1.75"	25" - 40"	300 lb
UA-SHAS-2540	UA-SHAV-2540	19"	1.75"	25" - 40"	300 lb

Light Duty Shelf (Material: 16 ga. CRS)

Vented	Width (A)	Height (B)	Depth (C)	Usable Width (D)	Load Rating
UA-SH1	19.00"	1.75"	16.08"	17.375"	15 lb
UA-SH2	19.00"	3.50"	16.08"	17.375"	50 lb
UA-SH3	19.00"	5.25"	16.08"	17.375"	60 lb
UA-SH4	19.00"	7.00"	16.08"	17.375"	70 lb
UA-SH5	19.00"	8.75"	16.08"	17.375"	80 lb

Drawer (Material: 18 ga. CRS)

Solid with Lock	Width (A)	Height (B)	Usable Depth (C)	Load Rating
UA-DR2-LK	19.00"	3.5"	17.50"	50 lb
UA-DR3-LK	19.00"	5.22"	17.50"	60 lb
UA-DR4-LK	19.00"	6.97"	17.50"	70 lb

Adjustable Chassis Guides (Material: 12 ga. CRS)

Part Number	Width (A)	Height (B)	Depth C	Load Rating
CHGA-TN-2536-D	3"	1.75"	25"-36"	125 lb



Titan ZN4 - Data

Technical - Vertical Cable Management

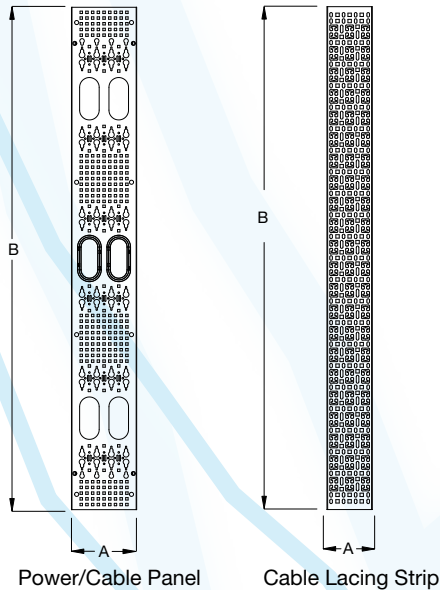

Power/Cable Panel (Material: 14 ga. CRS)

RU Height	7" Width (A 7.25")	Height (B)
47	PCP-47U-7	81.50"
44	PCP-44U-7	76.25"
42	PCP-42U-7	72.75"

Cable Lacing Strip (Material: 14 ga. CRS)

RU Height	5" Width (A)	Height (B)
47	CLS-47U-5	79.56"
44	CLS-44U-5	74.31"
42	CLS-42U-5	70.81"

Technical - Horizontal Lacing Bars

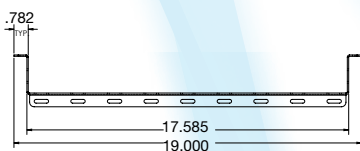

UA-LB2 (2" Depth)

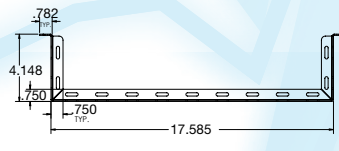

UA-LB4 (4" Depth)

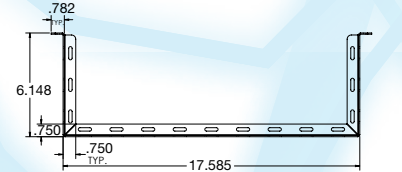

UA-LB6 (6" Depth)

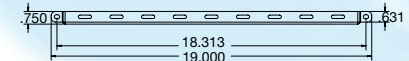
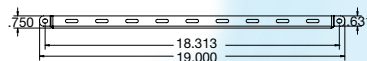
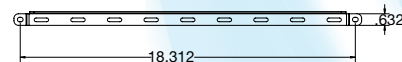

Note: Additional hardware is required if mounting #12-24 or #10-32 equipment in punched hole mounting channels. See hardware options in accessories section on page 14 of this catalog. Available in black finish only.

Technical - Horizontal Cable Management

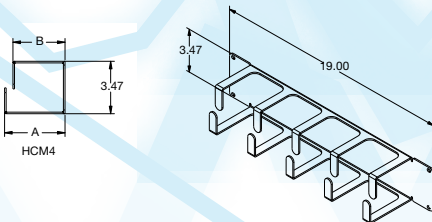

Horizontal Cable Management (Material: 18 ga. CRS)

Part Number	A	B
HCM7	7.00"	6.45"
HCM4	4.00"	3.45"

Technical - Blanking Panel

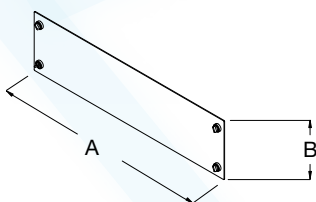

Blanking Panel (Material: 16 ga. CRS)

Part Number	Width (A)	Height (B)
BPT24-1U	19.56"	1.75"
BPT24-2U	19.56"	3.5"
BPT24-3U	19.56"	5.25"
BPT24-4U	19.56"	7"
BPT24-8U	19.56"	14"

Test results are available and supplied upon request.



AMCO's Test Report



Warranty & Policies

A. Choice of Method of Shipment

Unless otherwise specified, AMCO Enclosures are shipped as individual modules per ISTA packaging certification, with single width components assembled on the frame. Upon request, console arrangements will be completely assembled at the factory and shipped like furniture, via van, at no additional charge for assembly. Console arrangements may also be crated for shipment. Crating charges will be quoted for each such order, as console arrangements vary.

B. Design Changes

To allow continued progress, improvement, and adaptability in an advancing industry, AMCO Enclosures reserves the right to make product changes as deemed necessary.

C. Price Discounts

Purchase orders cannot be combined for discount advantages.

D. Proprietary Rights

This catalog and the drawings therein contain information deemed proprietary to AMCO Enclosures and are to be used only for the purposes for which they are submitted and, further, shall not be copied in whole or in part without the prior written consent of AMCO Enclosures.

E. Cancellation and Return

Cancellation and return charges begin at 40% with a minimum of \$50.00, depending on the nature of the order and the extent to which it has been processed. All returns have a 30-day, upon receipt time limit. Returns must be freight prepaid and not made without the prior written approval of AMCO Enclosures.

F. Terms

All quotations, order confirmations, published prices and discounts based on delivery F.O.B. AMCO Enclosures, 1 Innovation Drive, Des Plaines, IL 60016 freight collect. Invoice payment terms-net 30 days.

G. Sales Representation

Experienced factory sales representatives are available in all principle cities of the U.S.A., Canada and Mexico. Ask for sales representative listing. AMCO Enclosures equipment is thoroughly inspected prior to shipment. No returns of damaged equipment will be accepted without prior written approval of AMCO Enclosures.



Designed and
Manufactured in the USA

IMS Engineered Products is

ISO9001 Certified

Limited Warranty

AMCO Enclosures will repair or replace enclosures, accessories and components manufactured by AMCO Enclosures that are proven to be defective in material or factory workmanship under normal use during the period of this warranty.

Warranty Period

10 years from date of purchase. (Non-transferable)

This warranty does not cover:

- Failure in whole or part resulting from misuse, alteration, excessive temperature, excessive humidity, corrosive environment or lack of maintenance.
- Any materials or components used or manufactured pursuant to the purchaser's specifications.
- Items ordered in error or not required.

Power/Accessories

Warranty as specified by manufacturer.

Warranty Repair

Purchaser shall obtain controlled authorization number before returning any items alleged to be defective to AMCO Enclosures.

Inspection

AMCO Enclosures shall have the right to inspect any and all allegedly defective items on-site at purchaser's convenience.

Disclaimer of Consequential Damages and Limitations of Implied Warranty

AMCO Enclosures disclaims any responsibility for loss of time or use of parts or equipment wherein AMCO Enclosures components, or accessories are used. This includes any transportation, other incidental or consequential damages. Any implied warranties including the implied warranty of merchantability and fitness for intended use are limited to the duration of this written warranty.

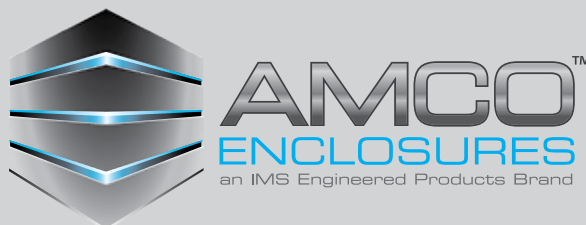

1 Innovation Drive
Des Plaines, IL 60016
www.amcoenclosures.com
847-391-8100